

## Specifications

Housing	Glass fibre reinforced Polyamide (PA 6.6)
Plunger	Polyacetal POM/(PA 4.6)
Mechanism	Snap-action coil spring mechanism with stainless steel spring
Functions	Change-over, normally closed or normally open
Contacts	Fine Silver, Gold plate on silver, Gold alloy on silver palladium (crosspoint)
Terminals	Gold flashed
Temperature range °C	-40°C to +85°C/120°C
Mechanical life	5 × 10 <sup>6</sup> cycles minimum (impact free actuation) for the cowl 3 × 10 <sup>6</sup>
Protection	IP40, IP6K7 (depend on type), Flux-proof terminal entries (for all types)
Mounting	Side mounting (moulded mounting pegs on request)
Actuators	Plain lever, cam follower, roller lever, simulated roller (cam follower) lever
Accessories	Lug mounting frame, clip-on terminals cover, insulating sheet

Circuit diagram

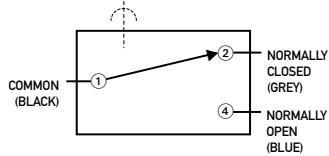

Dimensions

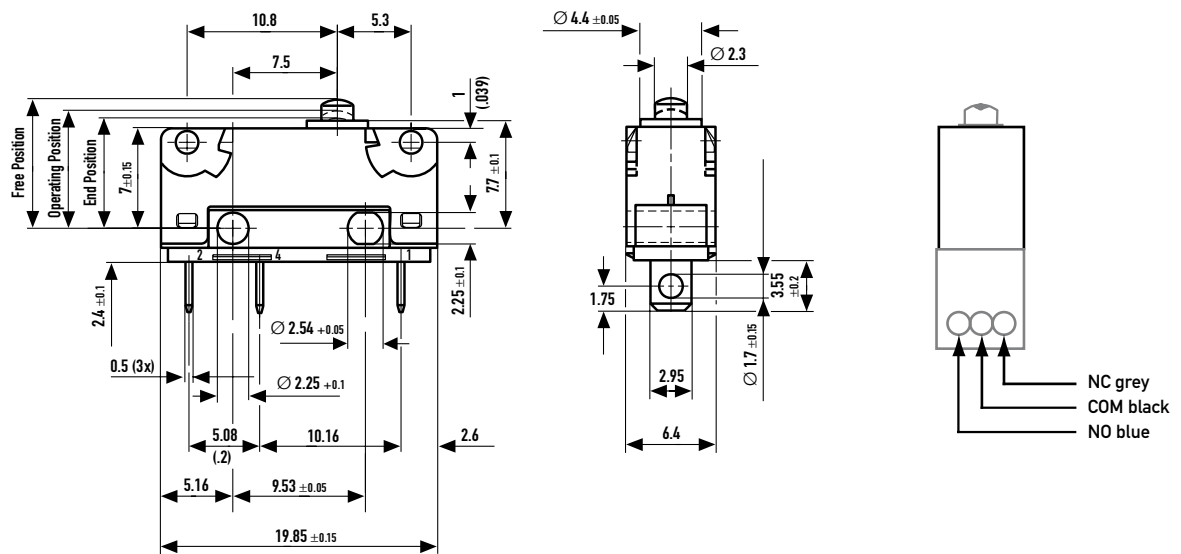

### Prewired version with cable box

For type coding key please contact Saia-Burgess

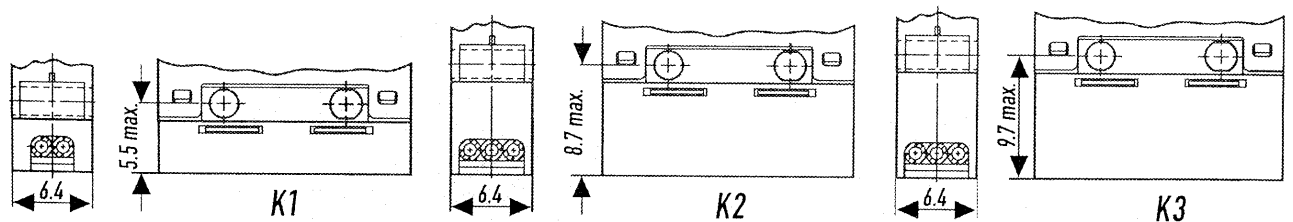

Standard cable FLRY 0.5 mm<sup>2</sup> with max. outside diameter 1.8 mm  
Standard cable box is K2

# V4NC

## Operating Characteristics

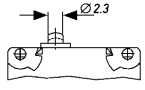
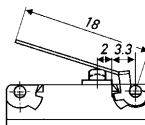
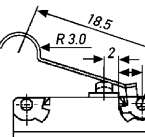
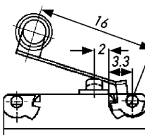
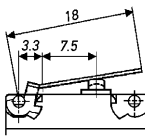
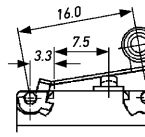
Actuator	Reference	Actuating Force Maximum		Release Force Minimum		Free Position Maximum		Operating Position		Movement Differential Maximum	
		(N)	(ozf)	(N)	(ozf)	(mm)	(in)	(mm)	(in)	(mm)	(in)
Plunger 	V4NC..	1.7	6,114	0.3	1,079	9.2	0.362	8.4 ± 0.3	0.331 ± 0.012	0.1	0.004
	V4NCE..	1.7	6,114	0.3	1,079	9.7	0.382	8.9 ± 0.3	0.35 ± 0.012	0.1	0.004
	V4NCS..	2.5	8,992	0.5	1,798	9.2	0.362	8.4 ± 0.3	0.331 ± 0.012	0.1	0.004
	V4NCSE..	2.5	8,992	0.5	1,798	9.7	0.382	8.9 ± 0.3	0.35 ± 0.012	0.1	0.004
A1 Lever  Width of lever 4.0mm/0.16 in	V4NC..	0.8	2,877	0.07	0,251	13.4	0.527	10.85 ± 1.3	0.427 ± 0.051	0.4	0.016
	V4NCE..	0.8	2,877	0.07	0,251	14.8	0.582	12.4 ± 1.3	0.488 ± 0.051	0.4	0.016
	V4NCS..	0.9	3,237	0.1	0,359	13.4	0.527	10.8 ± 1.3	0.425 ± 0.051	0.4	0.016
	V4NCSE..	0.9	3,237	0.1	0,359	14.8	0.582	12.4 ± 1.3	0.488 ± 0.051	0.4	0.016
AC Lever  Width of lever 4.0mm/0.16 in	V4NC..	0.8	2,877	0.07	0,251	16.1	0.634	13.5 ± 1.3	0.531 ± 0.051	0.4	0.016
	V4NCE..	0.8	2,877	0.07	0,251	17.6	0.693	15.1 ± 1.3	0.594 ± 0.051	0.4	0.016
	V4NCS..	0.9	3,237	0.1	0,359	16.1	0.634	13.4 ± 1.3	0.527 ± 0.051	0.4	0.016
	V4NCSE..	0.9	3,237	0.1	0,359	17.6	0.693	15.1 ± 1.3	0.594 ± 0.051	0.4	0.016
AR Lever  Width of lever 4.0mm/0.16 in	V4NC..	0.8	2,877	0.07	0,251	18.1	0.712	16 ± 1.2	0.63 ± 0.047	0.4	0.016
	V4NCE..	0.8	2,877	0.07	0,251	19.2	0.756	17.3 ± 1.2	0.681 ± 0.047	0.4	0.016
	V4NCS..	0.9	3,237	0.1	0,359	18.1	0.712	15.9 ± 1.2	0.626 ± 0.047	0.4	0.016
	V4NCSE..	0.9	3,237	0.1	0,359	19.2	0.756	17.3 ± 1.2	0.681 ± 0.047	0.4	0.016
A10 Lever  Width of lever 4.0mm/0.16 in	V4NC..	1.3	4,676	0.13	0,467	10.7	0.421	9.4 - ± 0.7	0.37 ± 0.027	0.2	0.008
	V4NCE..	1.3	4,676	0.13	0,467	11.5	0.453	10.2 ± 0.7	0.401 ± 0.027	0.2	0.008
	V4NCS..	1.8	6,474	0.2	0,719	10.7	0.421	9.3- ± 0.7	0.366 ± 0.027	0.2	0.008
	V4NCSE..	1.8	6,474	0.2	0,719	11.5	0.453	10.1 ± 0.7	0.397 ± 0.027	0.2	0.008
AR0 Lever  Width of lever 4.0mm/0.16 in	V4NC..	1.3	4,676	0.13	0,467	15.8	0.622	14.7 ± 0.6	0.579 ± 0.023	0.2	0.008
	V4NCE..	1.3	4,676	0.13	0,467	16.5	0.649	15.4 ± 0.6	0.606 ± 0.023	0.2	0.008
	V4NCS..	1.8	6,474	0.2	0,719	15.8	0.622	14.7 ± 0.6	0.579 ± 0.023	0.2	0.008
	V4NCSE..	1.8	6,474	0.2	0,719	16.5	0.649	15.4 ± 0.6	0.606 ± 0.023	0.2	0.008

Operating characteristics shown above are specified from mounting hole centres.

Over travel: Flush with case. (7.8 mm min) The case should not be used as an end stop.